



Pentalift Equipment Corporation



Loading Dock Design Presentation





History



- Established in 1983 by Arne Pedersen.
- Pentalift consists of two Divisions, Loading Dock Division and Lift Table Division.
- Loading Dock Division manufactures a complete line of Loading Dock Equipment, Vehicle Restraints, Dock Seals and Dock Shelters.
- Lift Table Division focuses on Custom Designed Lifting Equipment.
- 25+ Years Industry Experience.



Specifications

- Pentalift is proud to be listed as an approved supplier on MasterSpec.
- Pentalift is incorporating product specifications which can be downloaded from the Pentalift Website.
- Our Dock Design Guide contains important factors for Architects to consider in order to achieve proper dock design.

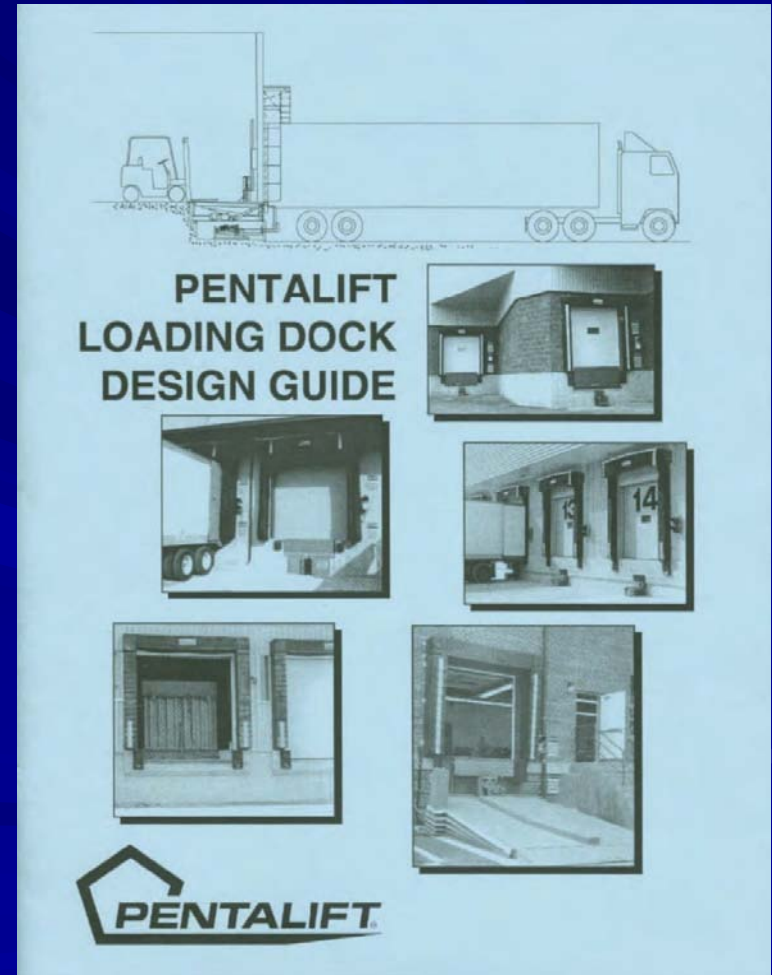



Factors Affecting Dock Design

1. Loading Dock Safety Issues.
2. Type of Facility.
3. Trailer Design.
4. Dock Equipment Type.
5. Building Design/Apron.





➤ Factor # 1 Dock Safety

Dock Safety Issues

- Potential Accidents at the loading Dock.
 - Void in the Floor.
 - Unscheduled Trailer Departure.
 - Trailer Creep.
 - Trailer Landing Gear Collapse.
 - Trailer Tip Over.
 - Forklift Roll Off.
 - Stump-Out.

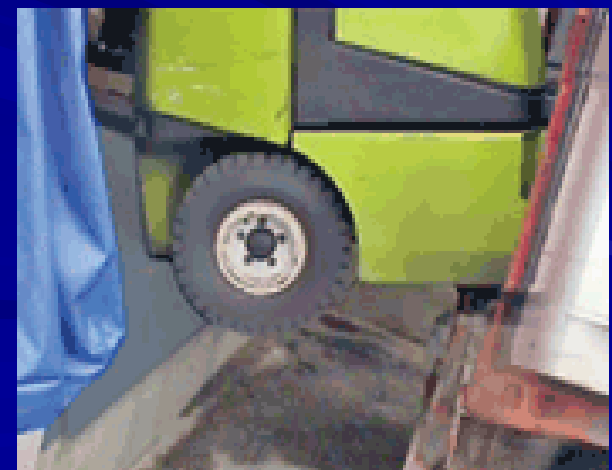



➤ Factor # 1 Dock Safety





➤ Factor # 2 Type of Facility

Other Facility Factors

■ Facility Type, Truck Fleet and Loading style will affect:

1. Door Size.
2. Dock Height.
3. Dock Leveler Size.
4. Dock Leveler Capacity.
5. Dock Leveler Lip Length.
6. Bumper Projection.
7. Style of Dock Seal or Dock Shelter.
8. Style of Vehicle Restraint required.





➤ Factor # 3 Trailer Design

Trailer Design Affects Dock Design

- Trailer Bed Heights.
- Rear Impact Guards.
- Air Ride Suspension.
- Trailer Inside Width.
- Trailer Inside Height.
- Trailer Tailgates.



➤ Factor # 3 Trailer Design

Trailer Bed Heights

Type of Trucks/Trailers:

- Reefer (refrigerated).
- Semi Trailers.
- Lowboys.
- Air Ride suspension.
- Step Trailers.

Truck/Trailer Bed Height	Minimum	Maximum
Container	56"	62"
Reefer	50"	62"
Flatbed	48"	60"
Double Axle Semi-Trailer	44"	52"
City Delivery	44"	48"
Straight Truck	36"	48"
High Cube Van	36"	42"
Furniture/Low Boy	24"	36"
Step Van	20"	30"



➤ Factor # 3 Trailer Design

- Goal is to create a Dock Height and Door Size that will match up to the trailers that will be used.

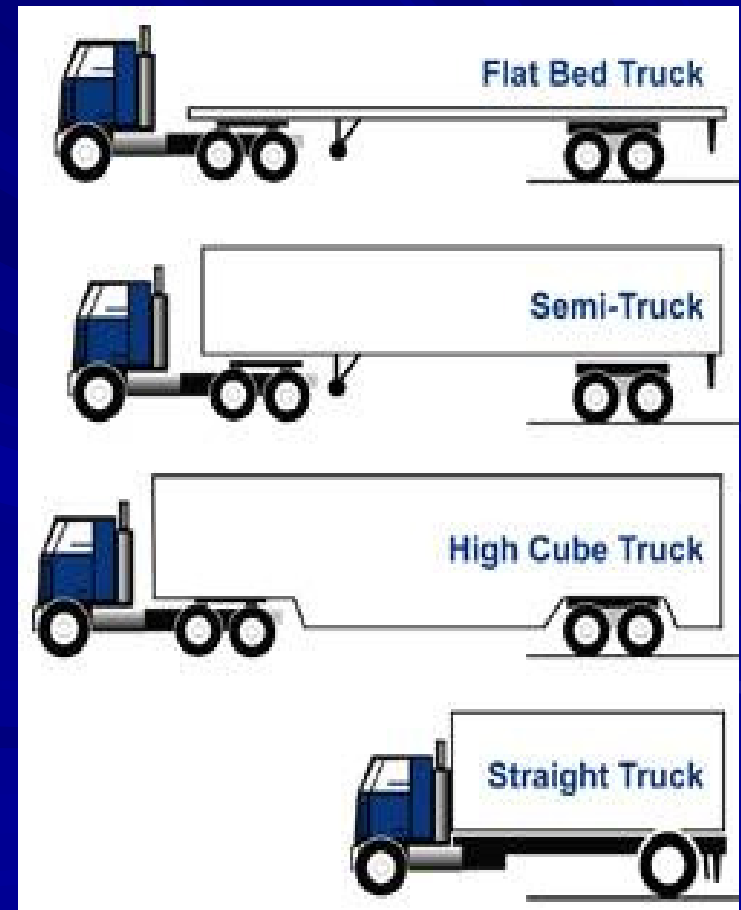
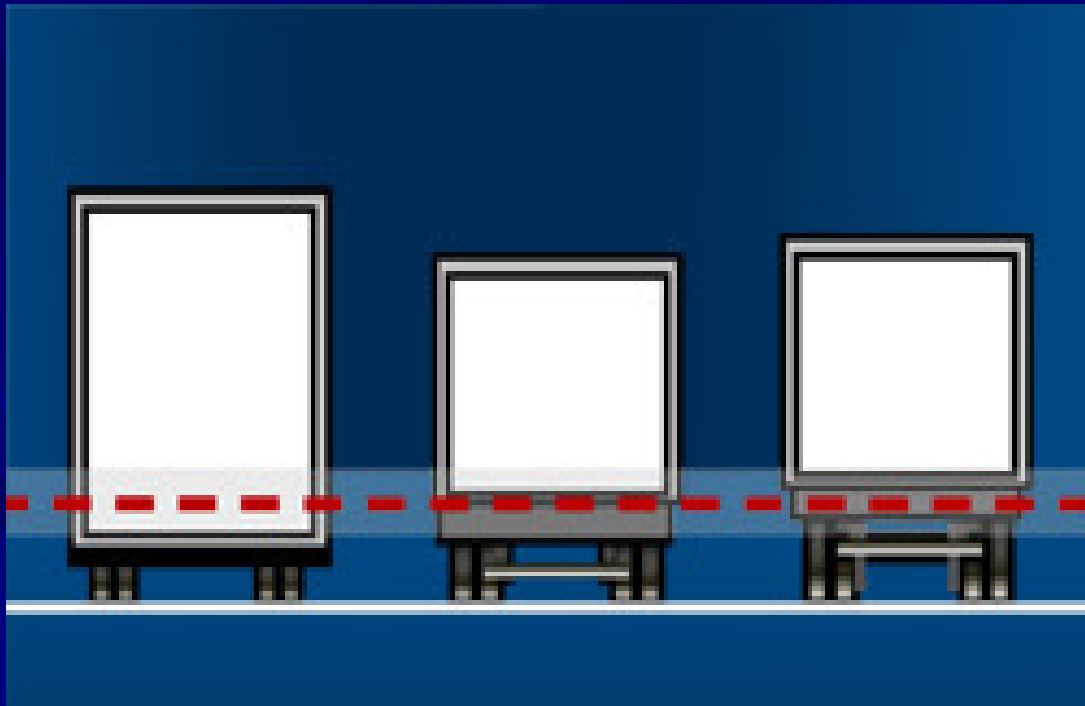



➤ Factor # 3 Trailer Design

Rear Impact Guards (R.I.G.)

- Maximum 22" (560mm) from Grade to R.I.G.
- Many R.I.G.'s can get as low as 10" depending on approach slope and suspension (Air Ride).
- Ensure Axle is placed at farthest rear position.
- Maximum 12" (305mm) from rear of trailer to R.I.G.
- 4" x 4" horizontal member is now standard.

Rear view of trailer

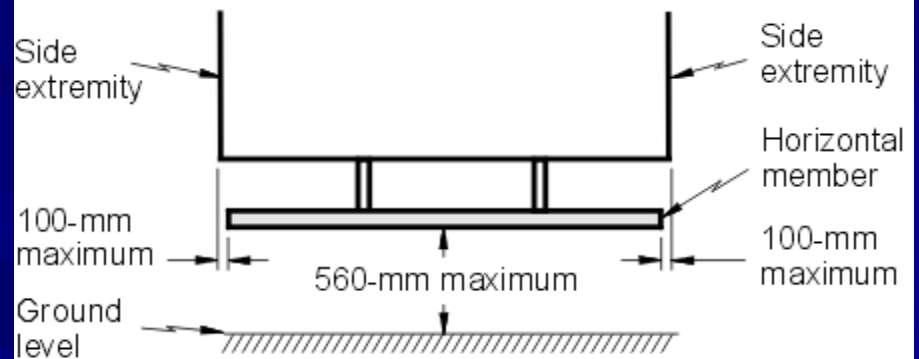

Side view of trailer

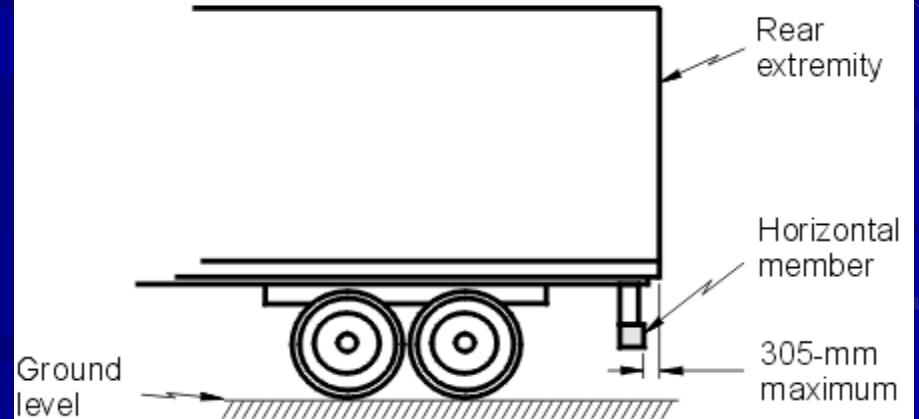

Note:
Drawings not to scale



➤ Factor # 3 Trailer Design

Air Ride Suspensions

- Creates a more cushioned ride that helps protect product.
- At the Loading Dock the suspension can cause problems for dock levelers, vehicle restraints, dock seals and bumpers.
- This trailer movement can cause the trailer to creep forward away from the dock, causing the Dock Leveler lip to lose penetration into the bed of the truck and a potential safety issue.



➤ Factor # 3 Trailer Design

Trailer Height and Width

- Inside width on new style Trailers can be as much as 101" (8'-5") and allows for a 40" pallet and 48" pallet to fit side by side.
- Inside Height of up to 114" allows for double stacked loads to max out Trailer volume.

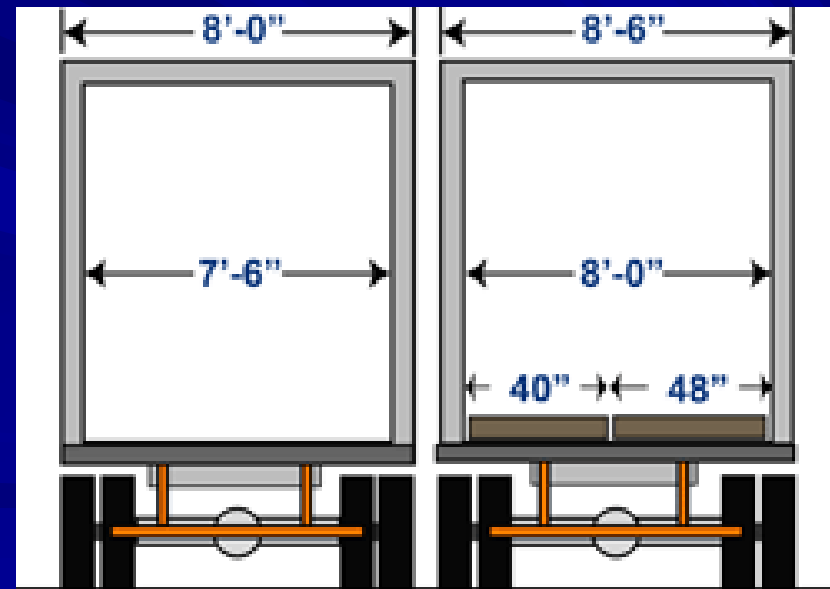

➤ 101" Inside width trailer not shown



➤ Factor # 3 Trailer Design

Recommended Door Size

- With trailers becoming wider the recommendation is to consider using 9'W or even 10'W x 10'H Dock Doors.
- This will give full access to the trailer for possible full width and full height loading/unloading.
- Door size should match truck size and load style.



➤ Factor # 3 Trailer Design

Dock Leveler Width

Full Width End Loading

– Drop off zone

- space created between side of deck and side of truck/trailer giving the potential for material handling equipment to drop through.
- Note: It is not recommended to taper the lips on 7' wide Dock Levelers.

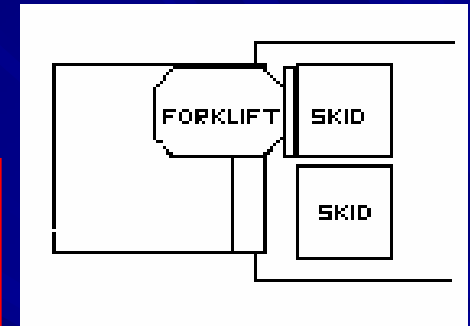



➤ Factor # 3 Trailer Design

Recommended Dock Leveler Width

- Wider Trailers allow the possibility of wider loads and use 2 x 48" W pallets.
- Also a 7'W Dock Leveler will assist with full width access for the forklift over a standard 6' wide Dock Leveler.



➤ Factor # 3 Trailer Design

Determining Dock Leveler Deck Length

Type of Material Handling Equipment can affect Dock Leveler length.

■ Slope requirements.

	Maximum	Ideal
– Pallet Truck	7%	3.5%
– Electric Forklift	10%	5.0%
– Gas Forklift	15%	7.5%



➤ Factor # 3 Trailer Design

Recommended Dock Leveler Length

- The wider variety of trailer styles seen at the dock, the longer the Dock Leveler has to be to maintain smooth transition to the trailers and to maintain the float range with air ride suspensions.
- Standard lengths of 6' to 8' Long may not be enough.
- Consider 10' Long or more if needed.



➤ Factor # 4 Dock Equipment Type

Types Of Dock Equipment

- Hydraulic Dock Levelers.
- Mechanical Dock Levelers.
- Edge of Dock Levelers.
- Automatic Vehicle Restraints.
- Mechanical Vehicle Restraints.
- Automatic and Manual and Wheel Chocks.
- Dock Seals & Shelters.
- Dock Bumpers & Lights.



Edge of Dock

- Available in both Mechanical and Hydraulic models.
- Lower cost alternative to the pit style Dock Leveler.
- Suitable for lesser capacities and facilities with less frequent use.
- Suited for servicing minimal deviation in above and below level ranges.
- Excellent upgrade to aluminum plates.





➤ Factor # 4 Dock Equipment Type

Mechanical Dock Levelers

Features:

- Upward Bias Spring Systems.
- Mechanical Fallsafe.
 - Legs prevent deck from descending below dock level under a fallsafe situation.
- Fallsafe - where there is a load on the deck of the Dock Leveler and the truck/trailer supporting the lip of the Dock Leveler pulls away allowing deck to descend to lowest position.



➤ **WHEN TRUCK PULLS AWAY, LEGS WILL STOP THE FREE FALL**

➤ **THESE LEGS CAN CAUSE STUMP-OUT**



➤ Factor # 3 Trailer Design

Air Ride Trailer Effects on Mechanical Dock Levelers

- Mechanical Dock Levelers equipped with Fallsafe legs can complicate loading operations since they can prematurely engage and stop the downward movement of the Dock Leveler deck until the legs are manually disengaged.
- This causes the issue commonly referred to as “Stump-Out”. Stump-Out can damage the Dock Leveler and increase the potential for injuries to the dock worker.
- Stump-Out is eliminated by specifying Hydraulic Dock Levelers.



➤ Factor # 4 Dock Equipment Type

Issues with Mechanical Dock Levelers

■ Fallsafe Legs can Cause Stump-Out:

- The truck/trailer lowers when being loaded/unloaded allowing the mechanical fallsafe legs to engage.
- Then only the lip of the Dock Leveler will float with the truck/trailer after the deck stops descending.
- This creates an obstacle preventing the material handling equipment from leaving the truck/trailer (STUMP-OUT).





➤ Factor # 4 Dock Equipment Type

Hydraulic Dock Levelers

Features:

- Why use a Hydraulic Dock Leveler?
 - A Hydraulic Dock Leveler requires less maintenance than a Mechanical Dock Leveler, to keep operating efficiently.
 - Auto Return to Dock feature helps to eliminate void in the floor potential.
 - Uses Hydraulic vertical Float to maintain smooth transition and contact with trailer bed at all times eliminating Stump-Out.
 - Industry Proven Velocity Fuse system stops Dock Leveler within 3” in a free fall situation.



- **Hydraulic Dock Levelers create a more safe and ergonomic dock environment**



➤ Factor # 4 Dock Equipment Type

Vertical Storing Dock Leveler

- Vertical Storing Dock Leveler uses a fully hydraulic system to lower/raise deck and extend lip.
- Control Panel operation allowing interlocking to other electrical equipment.
- Used in facilities where cleanliness or temperature conditions must be maintained.

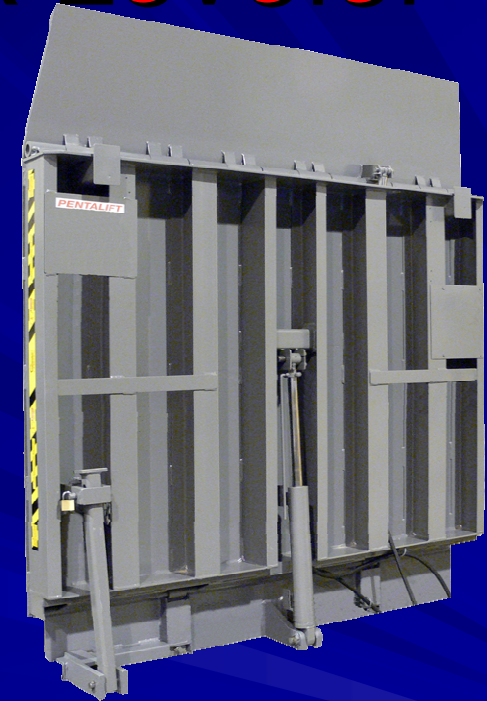

- **USED IN AREAS WHERE ENERGY EFFICIENCY IS REQUIRED**



➤ Factor # 4 Dock Equipment Type

Recommendation – GO HYDRAULIC!

- Why use a Hydraulic Dock Leveler?
 - Less Maintenance.
 - Increases Safety Factor at the dock area.
 - Ability to be interlocked to Door, Vehicle Restraint and / or Dock Shelter.
 - Eliminates “Stump-Out” from occurring.
 - Greater operating Range.
 - Floats 12” above and 12” below dock to maintain Lip contact with Trailer.



Capacity

What is Static Capacity?

- The amount of evenly distributed static weight that a Dock Leveler can support in the stored position.

What is Dynamic Capacity?

- The total rolling load that a Dock Leveler can safely support while the lip is resting on the truck/trailer bed.
- Industry Standards are rated using Static Capacity.



Capacity

Determine Static Capacity

Determine Impact Factor (I)

What is the Impact Factor?

- Multiplier used to compensate for the forces applied by a moving load.
- For normal applications, Pentalift uses a minimum impact factor of 2.5 for its standard series of Dock Levelers and a 2.0 for its Ultima series Dock Levelers.



Capacity

Sample Calculation

WHE=Weight of material handling equipment (plus any attachments)

WL=Weight of the load

I= Impact force

$$\text{WHE} = 10,000 \text{ lb}$$

$$\text{WL} = 5,000 \text{ lb}$$

$$I = 2.5$$

$$\text{Static Capacity} = (10,000 \text{ lb} + 5,000 \text{ lb}) \times 2.5$$

$$= 15,000 \text{ lb} \times 2.5$$

$$= 37,500 \text{ lbs Or } 40,000 \text{ lbs}$$

Capacity is rounded up to the next standard capacity.



➤ Factor # 4 Dock Equipment Type

Pit Design

Preformed Pit installation for:

Mechanical and Hydraulic Dock Levelers

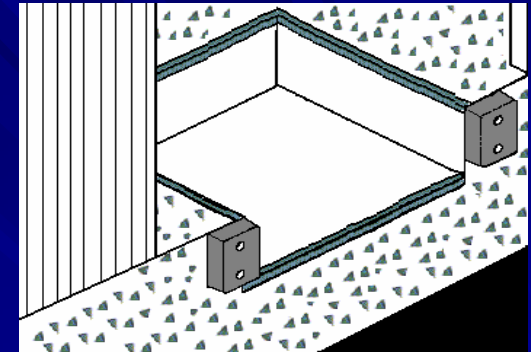

Advantages

- Installed after the floor is poured.
- Easily removed for replacement.

Disadvantages

- Pit formed in advance
- Separate curb angle required.
- Extra installation with welding in place.



➤ Factor # 4 Dock Equipment Type

Pour-In-Place Design

Pour-In Place style for:

Mechanical and Hydraulic Dock Levelers

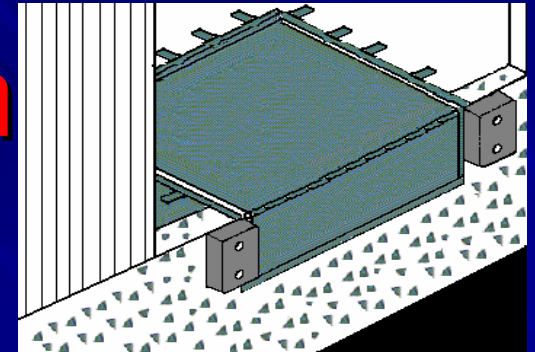

Advantages

- Requires concrete pad for installation.
- Concrete pours around Dock Leveler once leveled and secured.

Disadvantages

- Must be set up before pouring concrete.
- Harder to replace after installed.



Pour-In-Place

- Advantages of Pour-In-Place Dock Levelers for new construction or renovation.
Cost savings:
 - No forming of pits by contractor.
 - Dock Leveler comes installed in Pour in Place unit.
 - No curb angles.
- Pits are always square allowing leveler to perform better.
- Controls the quality of the installation.





➤ Factor # 4 Dock Equipment Type

Pit Design

Individual Pit or "T" Style for:
Vertical Storing Dock Leveler

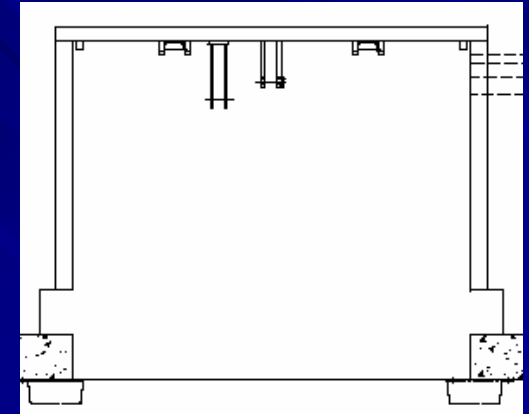

Advantages

- Provides concrete floor beside Dock Leveler.
- Flat plate option welds to embedded channel.

Disadvantages

- Pit formed in advance
- Separate curb angle required.
- Channel required when concrete poured.



➤ Factor # 4 Dock Equipment Type

Pit Design

Continuous Pit for:
Vertical Storing Dock Leveler

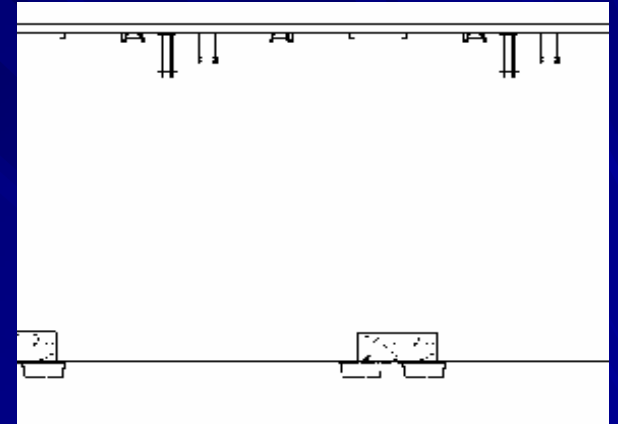

Advantages

- Step in floor requiring no preformed pit.
- Easy cleaning pit floor
- Flat plate option welds to embedded channel.

Disadvantages

- Channel required when concrete poured.
- Open area beside Dock Leveler.
- Stand required to mount controls.



➤ Factor # 1 Dock Safety

Why Wheel Chocks Don't Work

- Truck has enough force to easily pull over rubber chocks.
- Ice, snow and rain can affect its grip.
- Has to be manually placed creating a possible human error situation.
- They are easily lost and or damaged.





➤ Factor # 4 Dock Equipment Type

Hydraulic Vehicle Restraint

Features and Benefits:

- Creates a safe working environment at the dock.
- Locks onto Trailer R.I.G.
- Prevents trailer from early departure.
- Easy operation from Control Panel inside building.
- Effective communication with truck driver via outside lights.





➤ Factor # 4 Dock Equipment Type

Low Profile Vehicle Restraint

- Same Features and Benefits as HFR restraint Plus:
- 8-3/4" low profile stored height to lock to lower R.I.G. trailers.
- Perfect option for certain decline approaches.





➤ Factor # 4 Dock Equipment Type

Under Dock Leveler Vehicle Restraint

Features and Benefits:

- Stored under Hydraulic Dock Leveler creates a unobstructed dock approach.
- Has 40,000lb of restraining force.
- Ideal option at New Construction phase.





➤ Factor # 4 Dock Equipment Type

Under Dock Leveler Vehicle Restraint

- Trailer Creep/Early Departure Alarm.
 - When a truck/trailer tries to drive away while the Ultrahook is engaged on the R.I.G., an audible alarm will sound and the interior red light will flash to inform the operator of this situation.
- Under Dock Leveler.
 - Restraint stores completely under the Dock Leveler to protect it from the weather and any damage from equipment being used at the grade level.



➤ Factor # 4 Dock Equipment Type

Dock Seals/Shelters

- Generally Dock Seals offer a tighter environmental Seal.
- Truck Shelters allow for a wider variety of Trailers at the Dock and Larger Doors for End Loading.
- Application will determine Dock Seal or Dock Shelter type that best fits.





➤ Factor # 4 Dock Equipment Type

Dock Bumpers

- Molded Rubber – Basic style of bumper
 - Can easily wear due to air ride suspensions.
- Laminated – Provide good wear protection against air ride trailers.
- Steel Faced - Provides the best protection against air ride wear issues.

- Trucks can generate up to 300,000 lb of force at the dock.
- Air Ride Suspensions increase the wear on a bumper.
- Longer Bumpers are recommended to protect the wall from Air Ride trailers that can move vertically 6” to 8”.
- Bumper length will depend on dock height and trailer height.



Elevating Dock Lifts

- Available in pit-mounted and low-profile.
- Available in 3 sided pit design for greater flexibility at the loading dock.
- Suitable for applications where a traditional loading dock does not exist.
- Vertical travel of 59" allows for a wide range of truck bed heights.





Pentalift Surface Mounted Design

- Surface Mounted
– LPE685





➤ Factor # 4 Dock Equipment Type

Equipment Recommendations

Specify:

- Hydraulic Dock Levelers.
- Vehicle Restraints.
- Interlocking of Dock Equipment and Overhead Door.
- Laminated or Steel faced Bumpers.



➤ Factor # 2 Type of Facility

Facility Style Affects Dock Design

Application Affects Design:

- Refrigerated Warehouses
 - Cold temperature/Freezer - Clean operation.
 - May Require Vertical Storing Dock Levelers.
- Trucking Terminals
 - Fast paced - Cross Docking – Shunting
 - May use Mechanical or Hydraulic Dock Levelers.
- Distribution/Manufacturing Centers
 - System integration - Just in time delivery
 - Type of Loading/shipping will affect size of Dock Levelers needed.





➤ Factor # 5 Building Design

Building Design

- Dock Approach/Grade.
- Apron Spacing.
- Door Spacing.
- Dock Height.



➤ Factor # 5 Building Design

Dock Approach Grade

- Most dock approaches are either Level or Decline.
- Decline: Project bumper thickness 1" for every 1% of decline beyond the 4" thick bumpers required for a level approach.
e.g. 4% decline = 8" total bumper projection.
- This 8" can include a cantilever or haunch of 4" and Bumpers at 4" to = 8".
- Dock Seals or Dock Shelters will have to be tapered to match.

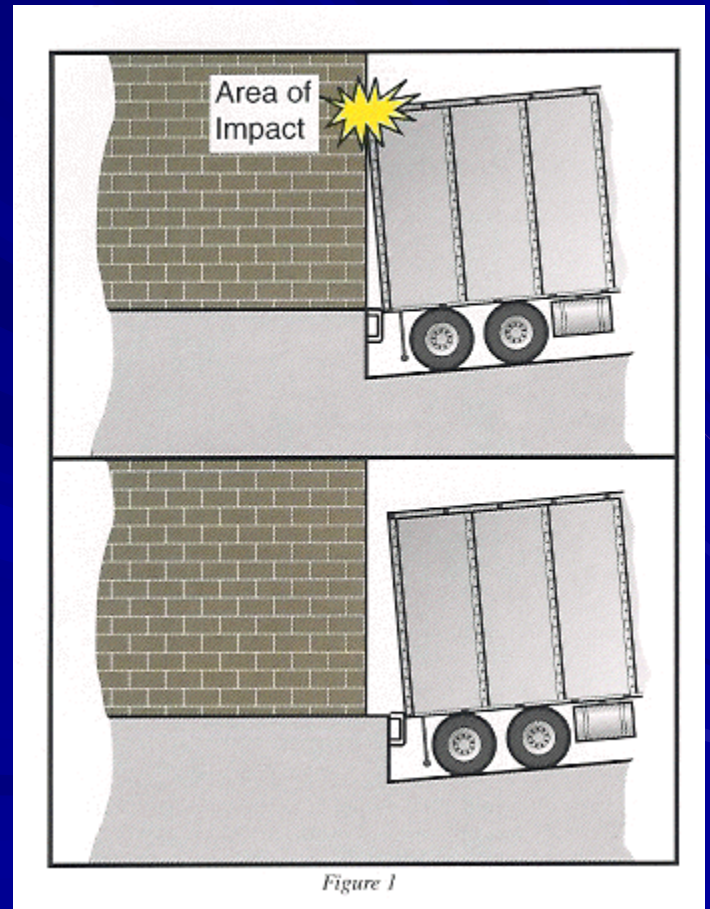

Apron Spacing

- To give trucks enough room to maneuver freely in and out of the dock. Recommendation is to provide twice the length of longest trailer plus a 10' safety factor.
- E.g. 70' Trailer and Cab $\times 2 = 140' + 10'$
 $= 150'$ apron spacing

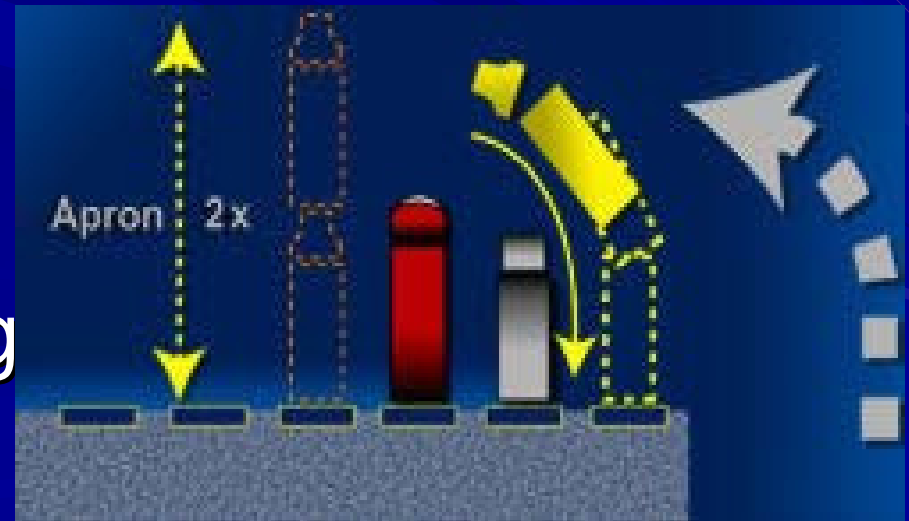



➤ Factor # 5 Building Design

Door Spacing

- Recommendation is to Design Doors with 12' centers.
- This allows for trucks with an overall width of 10' including side mirrors to easily maneuver in and out of the dock.
- Narrower spacing is possible when room is limited. In this case consider using Dock Seals or Dock Shelters with common members or saw tooth docks to maximize available space.



➤ Factor # 5 Building Design

Dock Height

- Most common Dock Height is 48" to 52".
- Goal is to match the dock height to the trailers that will be seen at the dock.
- Its ideal is have a slight incline into the trailer for loading and unloading.

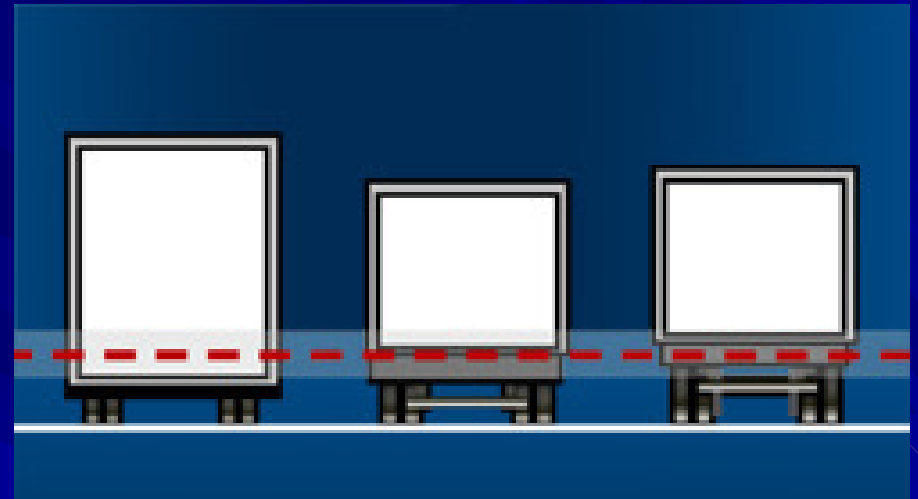



➤ Final Recommendations

Final Recommendations

- Safety
 - Specify Vehicle Restraints and Interlock to Dock Leveler and/or OHD.
- Equipment
 - Spec Hydraulic Dock Levelers.
- Dock Height
 - Match to Trailer Bed Heights.
- Door Size
 - Match to Trailer Width (est. 9'W x 10'H).
- Dock Leveler Size
 - Spec 7' Wide for End Loading.
 - Spec 8' long to 10' long for smooth Transition into Trailer.
- Capacity
 - Match to MGL and Forklifts Used.
- Bumpers
 - Spec Laminated or Steel Faced.
- Door Spacing
 - Spec 12' Centers Where Possible.
- Apron Spacing
 - Spec 2x Overall Truck length + 10'.



Please Contact
Pentalift Sales
Representative
For Additional
Information.

